

BBX 651 Specifications

- Fits 600 base unit
- 2 x 90mm Pop-up Wastes with Basket Strainer Wastes. Capable of adaptation to take Waste Disposal Unit
- Easily converted to Jumbo bowl
- Unique bowl design with 'Rock Pool' half bowl
- High design concept with half bowl innovations
- Large diagonal bowl/deep dimension
- Unique Stainless Steel accessories including Lock In Duo Bowl
- Shaped Hygenia Food Preparation Platter

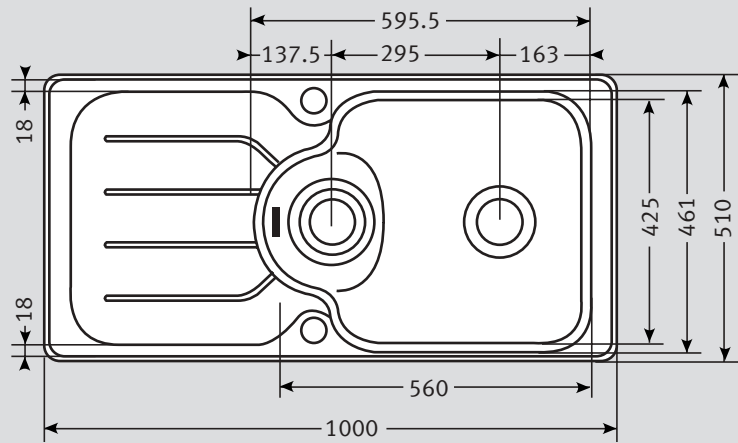

Material: 304 Austenitic 18/10 Stainless Steel

Application: Inset

Bowl size: 560 x 425 x 175

Drainer Format: Left or Right hand available

Cut-out size: 984 x 494 (cr=20)

Colour: Silk Stainless Steel

Seal: Polyurethane seal

Insulation: Black pads for sound

Heat Resistance: Up to 300°C

Earthing Point: Supplied with sink

Cabinet size:

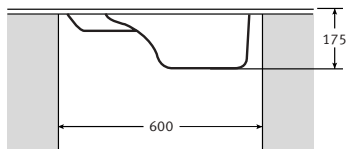

Fixing Clips: Double Edge

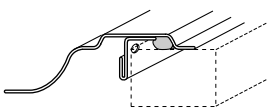

Fixing Clips: 'S' rail

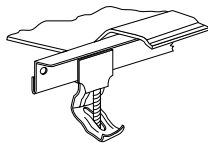

Suggested Plumbing Kit: 2 part

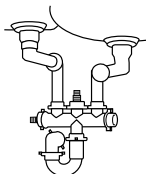

Waste: 2 x Lira 90mm Basket Strainer Waste with overflow & Pop-up assembly.

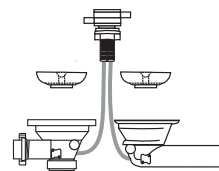

Overflow:

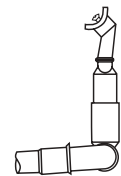

Accessories available:



Duo Bowl
Stainless Steel

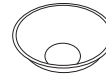

Measuring Bowl
Stainless Steel



Food Preparation Platter
Hygenia

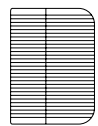

Grille
Stainless Steel

Taps: Any Franke tap can be utilised with this model*.

*Ceramic disc taps in certain installations or where there is a low head of water (below 4 metres) may not provide adequate flow rates. You are advised to check with your supplier.

Guarantee: Franke sinks are guaranteed for 25 years against manufacturing defect. Franke taps are guaranteed against defective materials and workmanship for 1 year in relation to coatings and finishes, and 5 years in relation to moving parts. Franke will replace (and where appropriate repair) defective sinks. In relation to taps, Franke will where appropriate provide replacement parts for your taps or replace your taps. Any associated or ancillary costs to be incurred by you as a result of replacement of Franke sinks and taps under this guarantee shall in all cases be previously approved by Franke UK Limited.

This guarantee is in addition to and does not affect your statutory rights.